

entia

Living

S M A R T F O R Y O U R H O M E

I N S T A L L A T I O N
M A N U A L

INSTALLATION MANUAL



Lighting

On/Off



On/off lights (and other on/off devices) have to be connected to the ENTIA living system as shown in the block diagram below. Note that on/off lights can be connected to either, Power Expander EL-E1801 or Power Expander EL-E1601 (the former being depicted in the block diagram below). One EL-E801 Power Expander supports up to 8 power outputs, while EL-E1601 Power Expander supports up to 16 power outputs. Dimmed lights must be connected to the Power Dimmer EL-D01 instead of Power Expander modules as shown later on in this document. Note that on the block diagram below, the elements and wiring for lighting connection is highlighted.

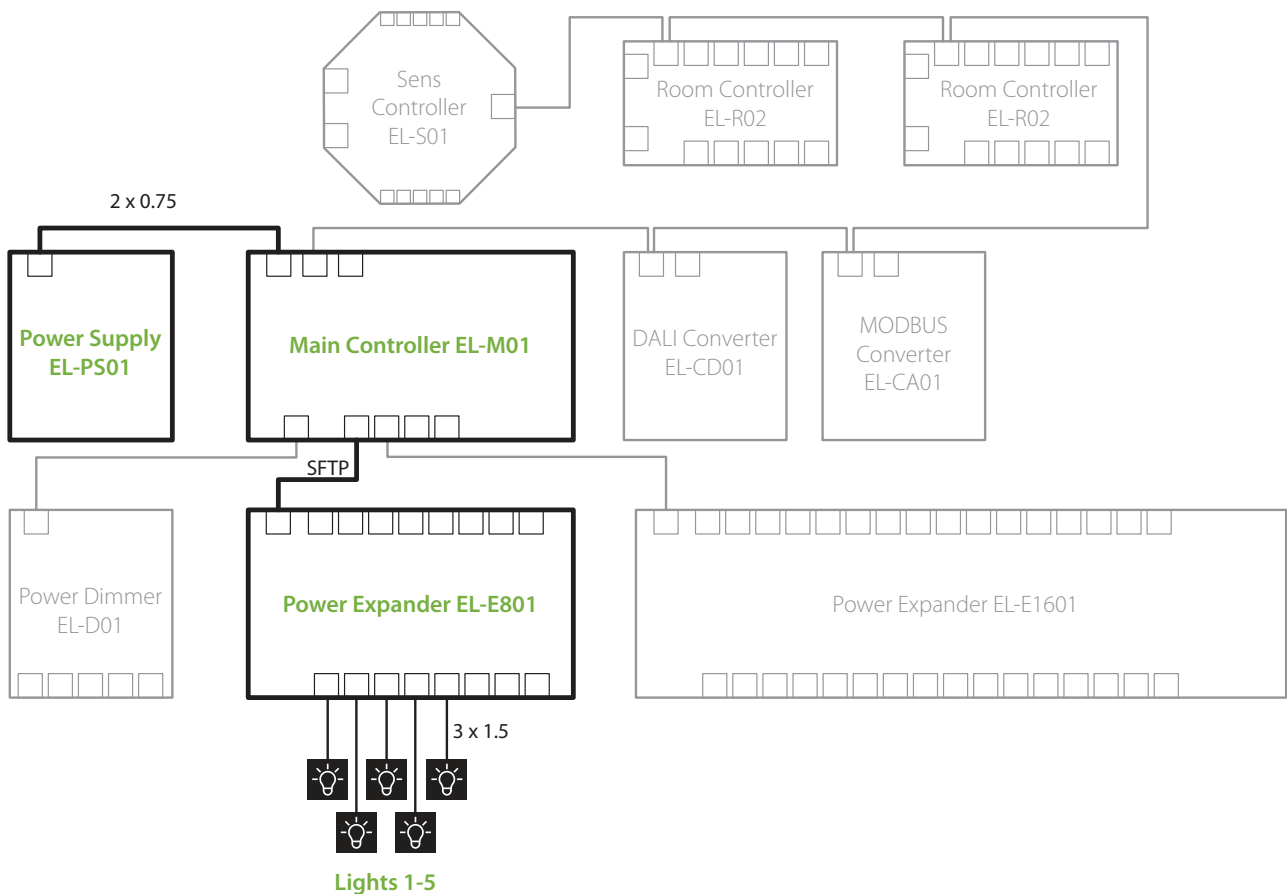

Lighting

On/Off

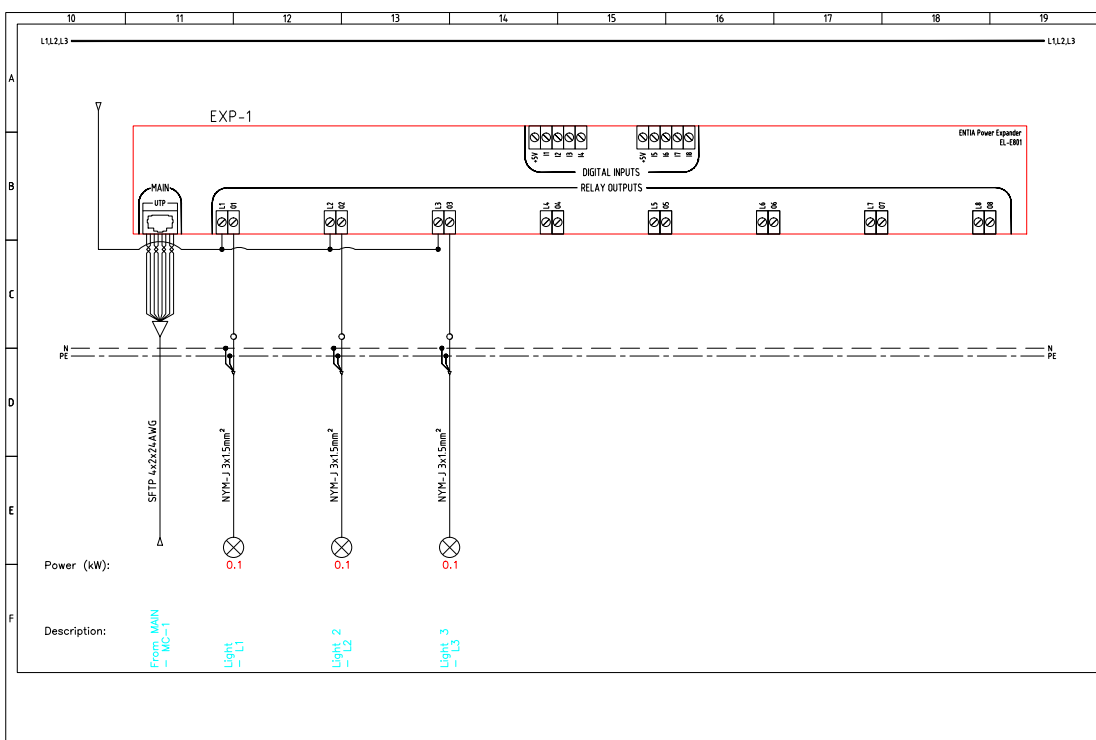
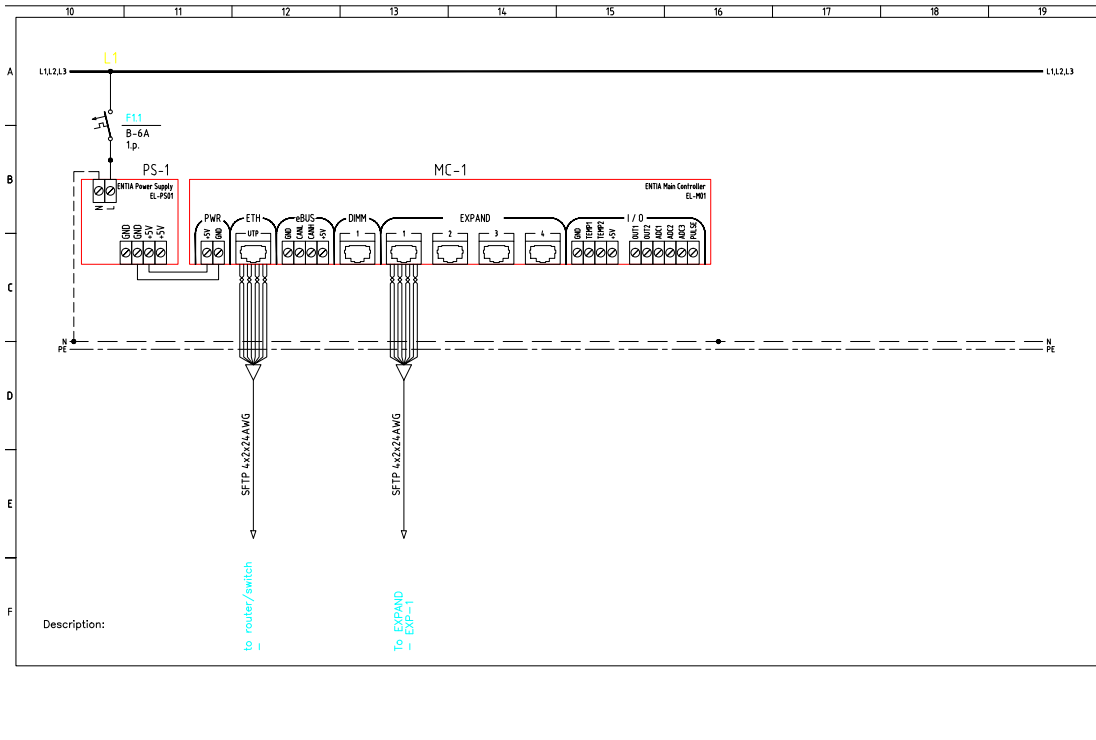

Lighting

Dimm



Dimmable lights have to be connected to the ENTIAliving system as shown in the block diagram below. Note that dimmable lights can be connected to Power Dimmer EL-D01. One EL-D01 Power Dimmer supports up to 5 dimmer outputs. Note that on the block diagram below, the elements and wiring for lighting connection is highlighted.

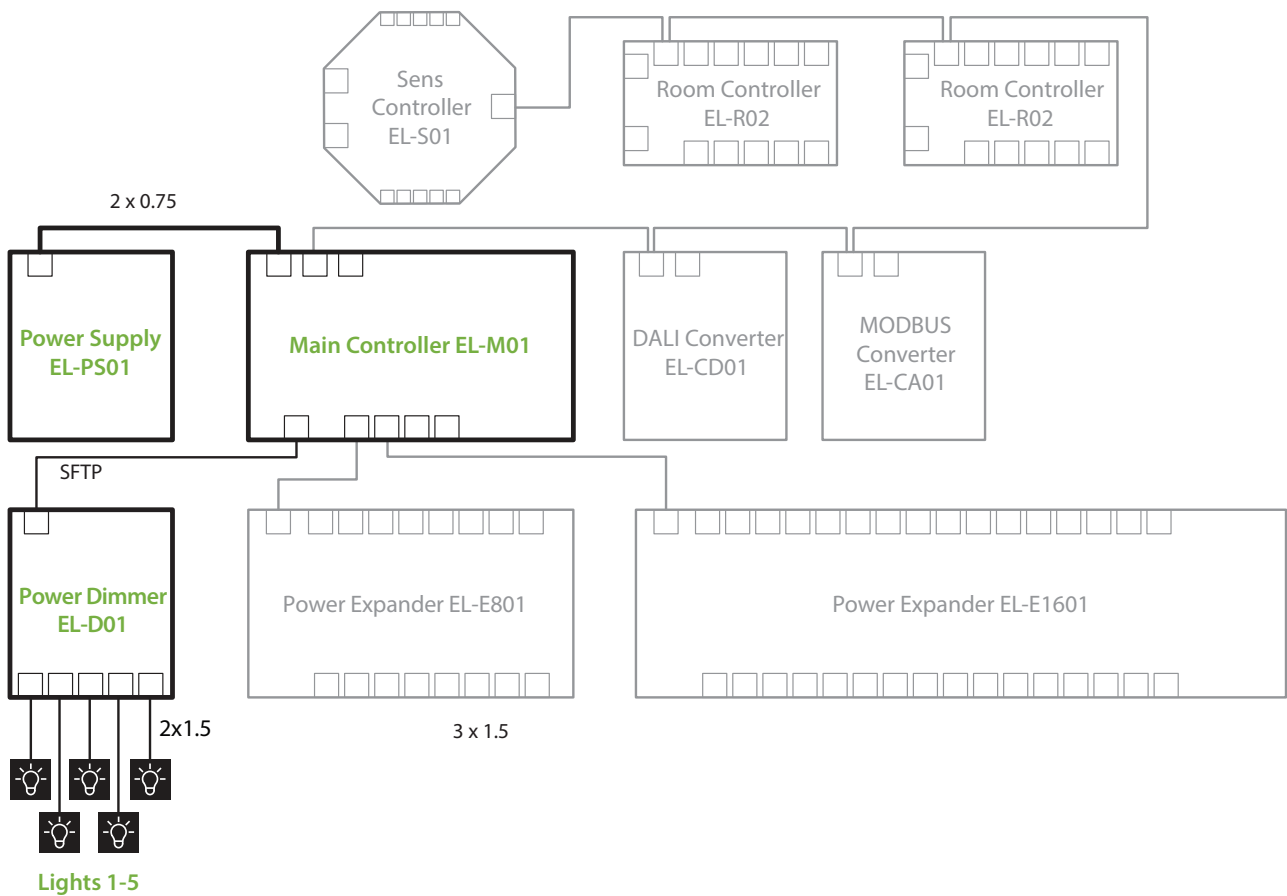

Lighting

Dimm

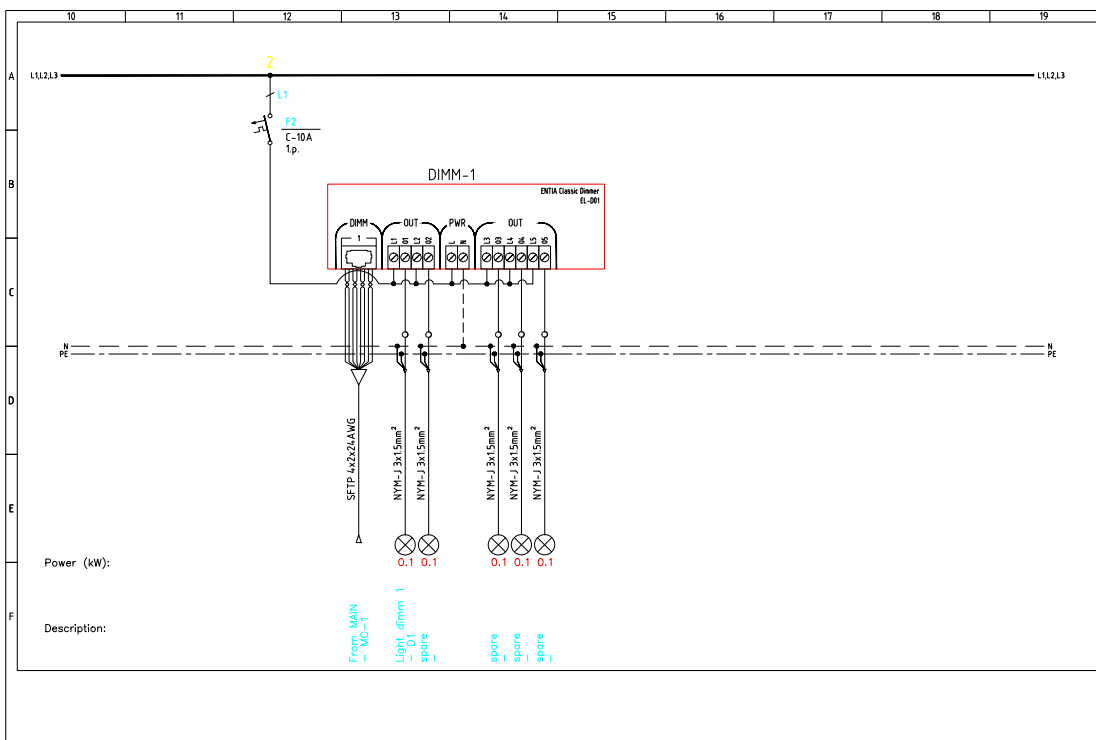
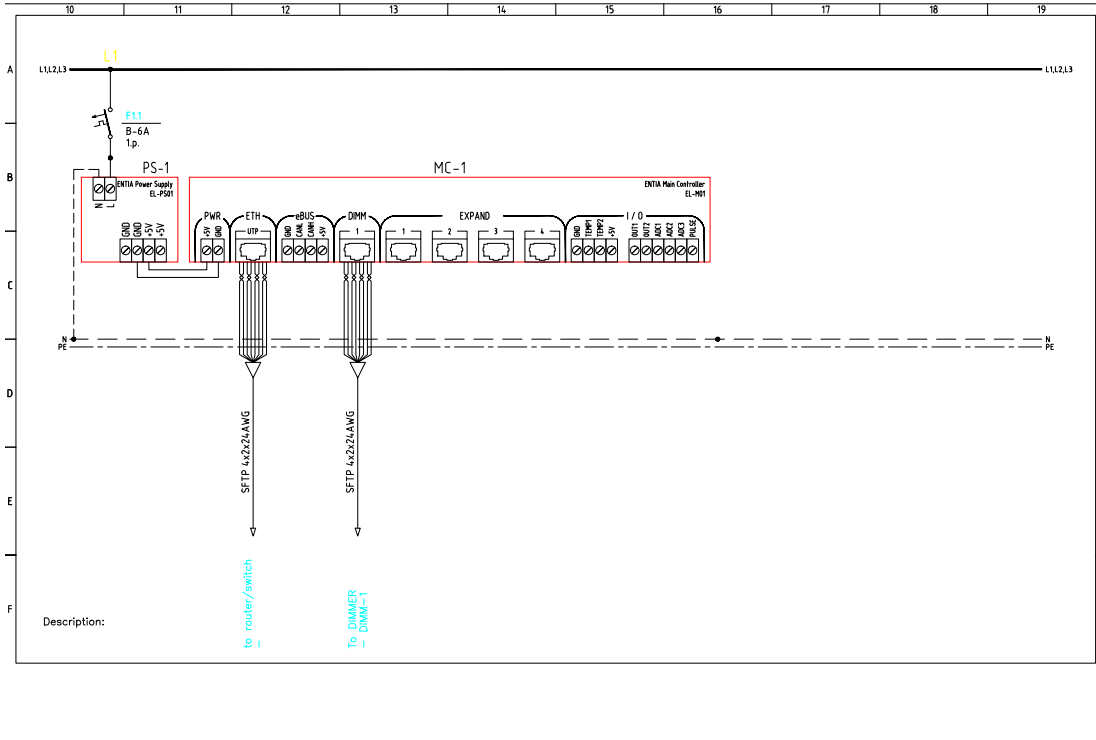

Lighting

DALI



DALI lighting devices have to be connected to the ENTIAliving system as shown in the block diagram below. Note that one ENTIAliving DALI Converter EL-CD01 can support up to 64 DALI lighting devices and 16 groups of DALI lighting devices. On the block diagram below, the elements and wiring for DALI lighting connection is highlighted.

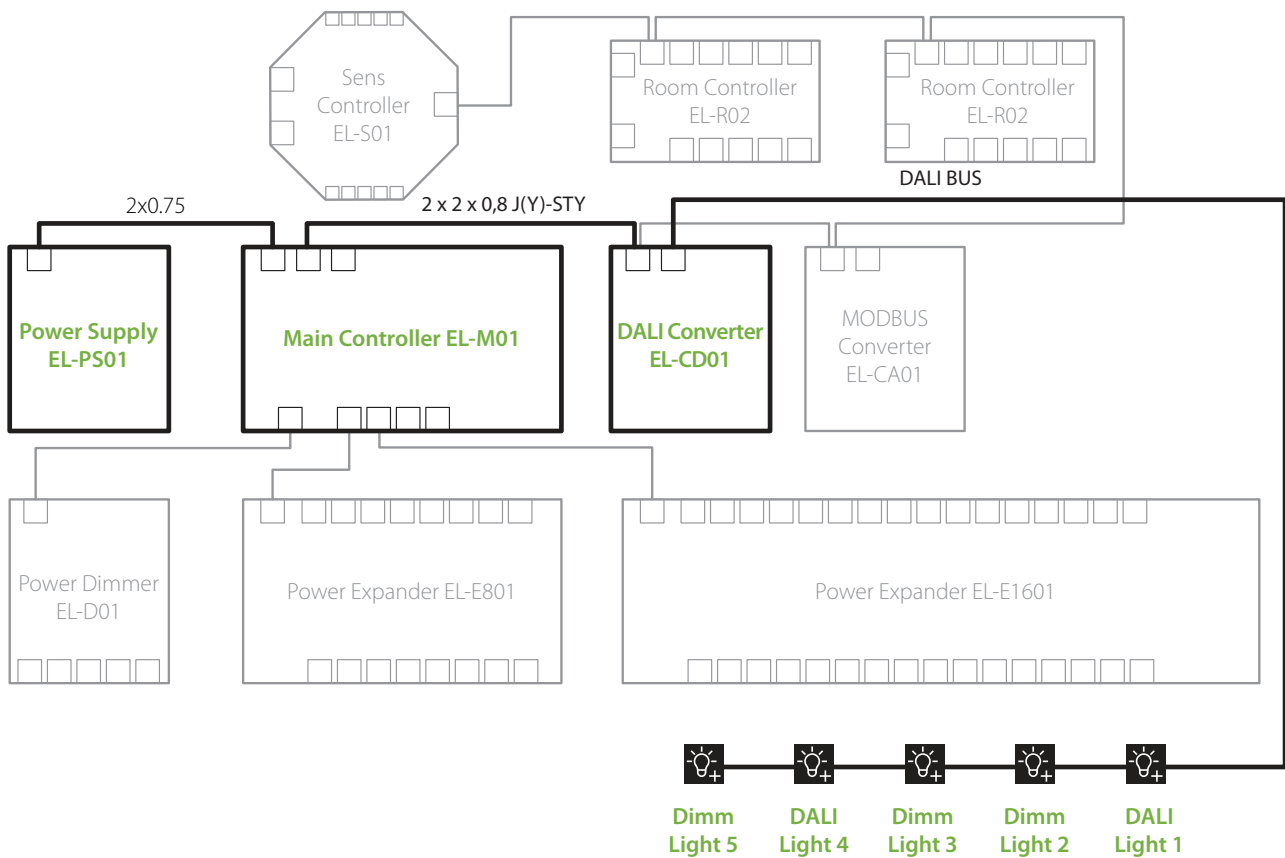

Lighting

DALI

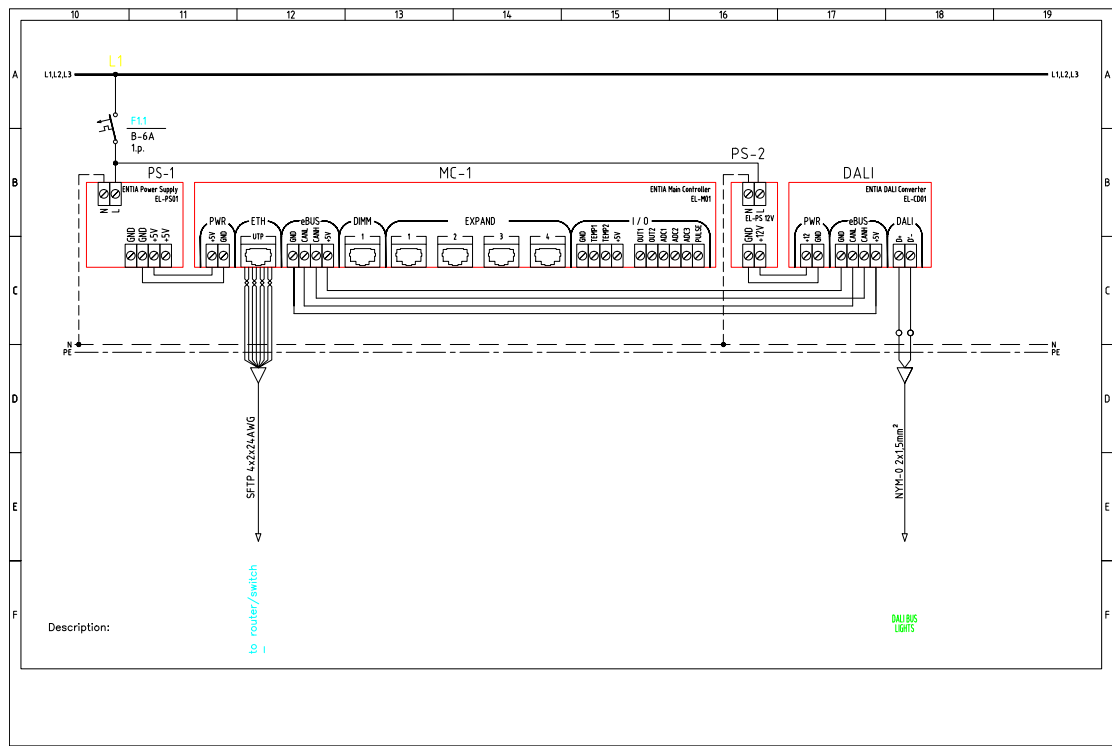

Heating&Cooling

Valves



On/off heating valves (and other on/off devices) need to be connected to the ENTIA living system as shown in the block diagram below. Note that described devices can be connected to either Power Expander EL-E801 or Power Expander EL-E1601 (the latter being depicted in the block diagram below). One EL-E801 Power Expander supports up to 8 power outputs, whereas EL-E1601 Power Expander supports up to 16 power outputs. Note that on the block diagram below, the elements and wiring for heating valve connection is highlighted.

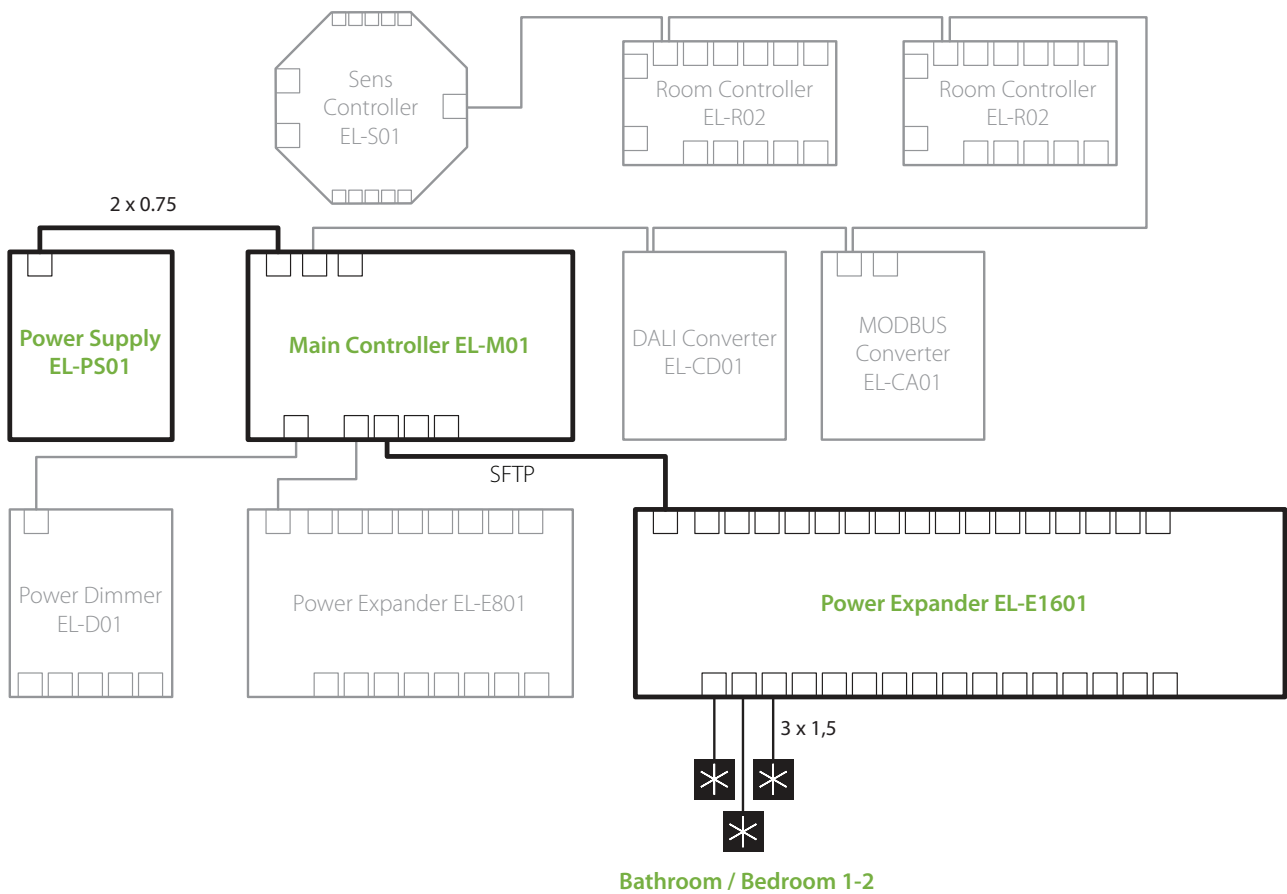

Heating&Cooling Valves

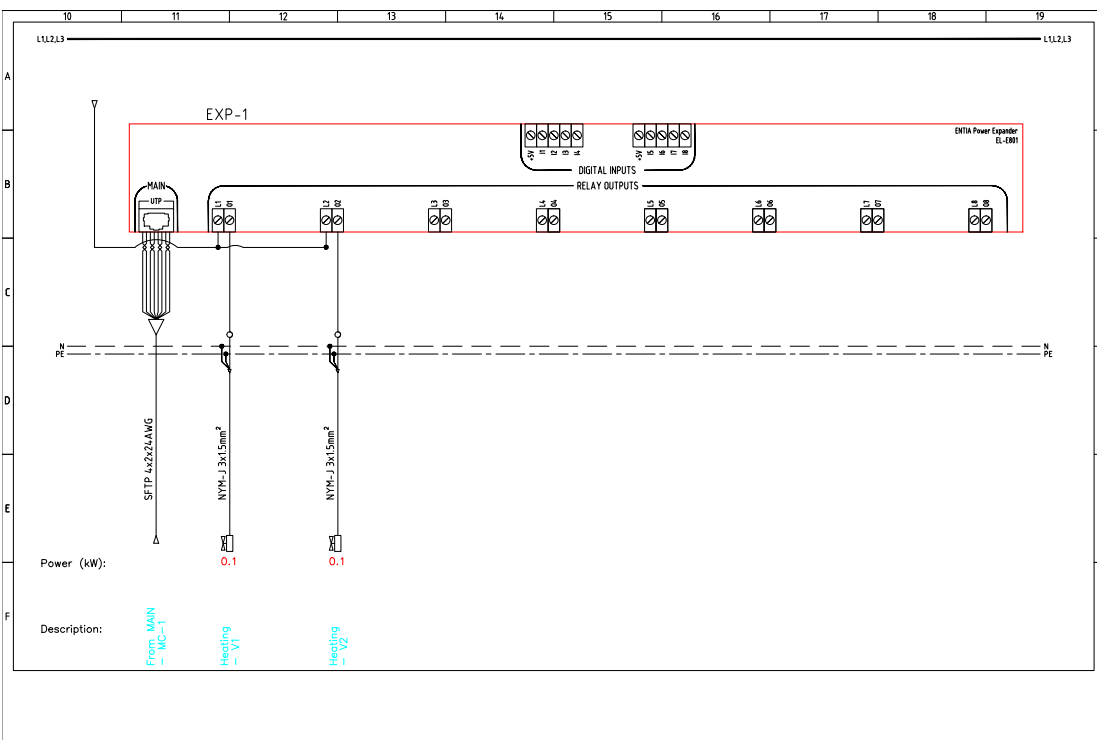
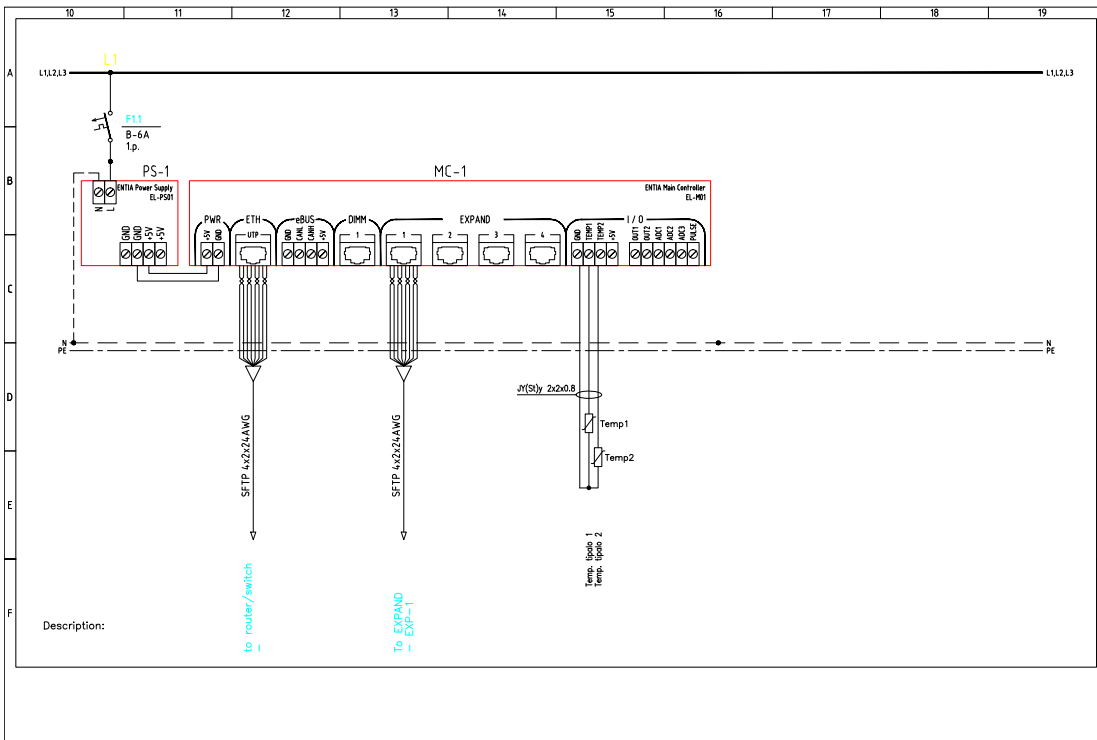

Heating&Cooling

Fan-Coils



Fan coils need to be connected to the ENTIA living system as shown in the block diagram below—the dashed line is connected in case of a 2 tube system (same tubes for hot and cold water), while it is not connected in a 4 tube system. Note that described HVAC devices can be connected to either Power Expander EL-E1801 or Power Expander EL-E1601 (the latter being depicted in the block diagram below). One EL-E801 Power Expander supports up to 8 power outputs, whereas EL-E1601 Power Expander supports up to 16 power outputs. Note that on the block diagram below, the elements and wiring for fancoil connection is highlighted.

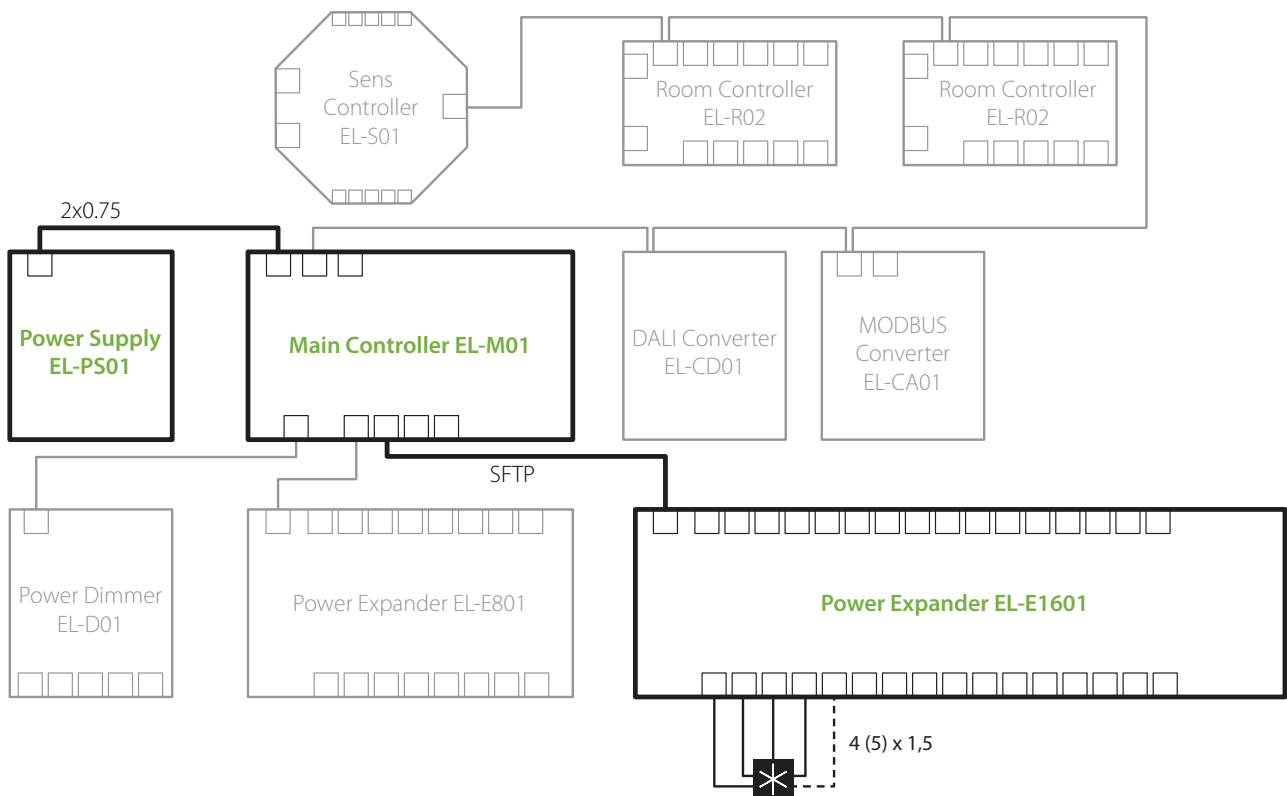

Heating&Cooling

Fan-Coils

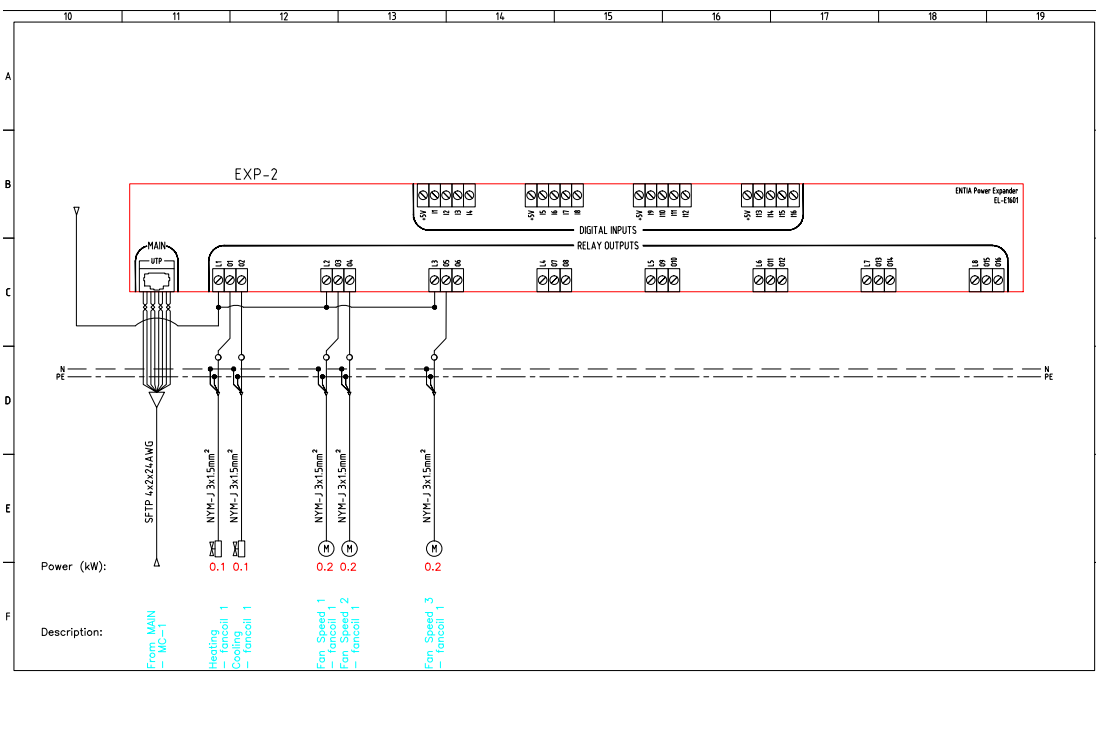
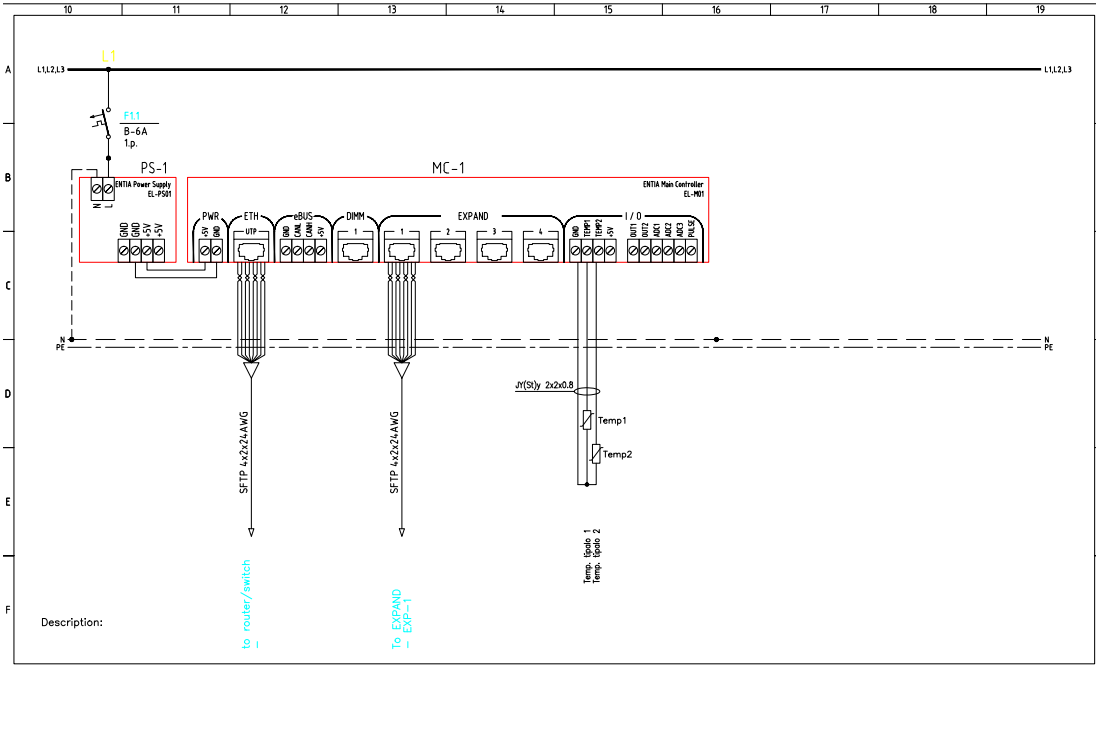

Shading

Shades, Blinds,...



Shading devices, such as shades, blinds, tendas and other have to be connected to the ENTIAliving system as shown in the block diagram below. As opposed to lighting installation (previous chapter), shading **MUST NOT** be connected to the ENTIAliving Power Expander EL-E801 and must instead be connected to the Power Expander EL-E1601. Note that on the block diagram below, the elements and wiring for shading connection is highlighted.

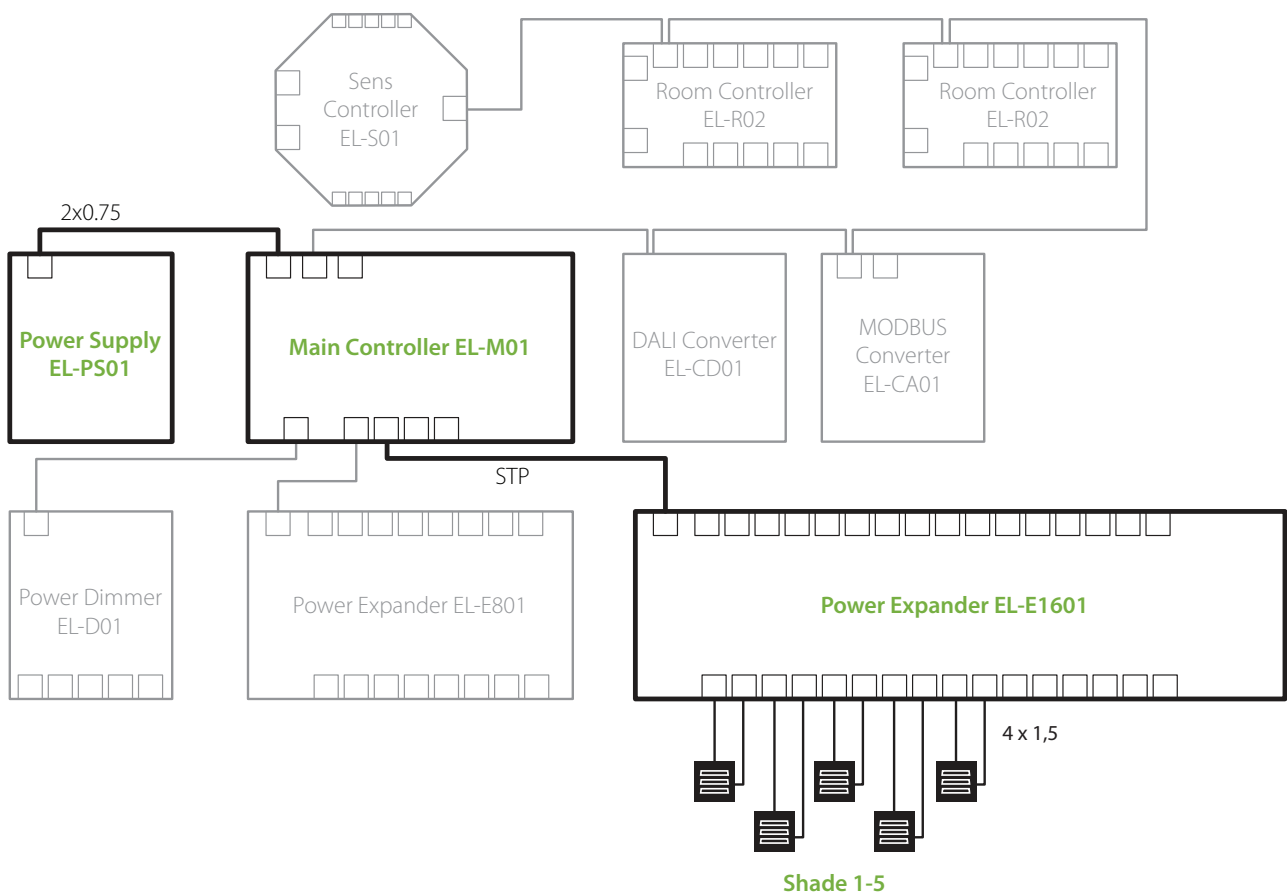

Shading

Shades, Blinds, ...

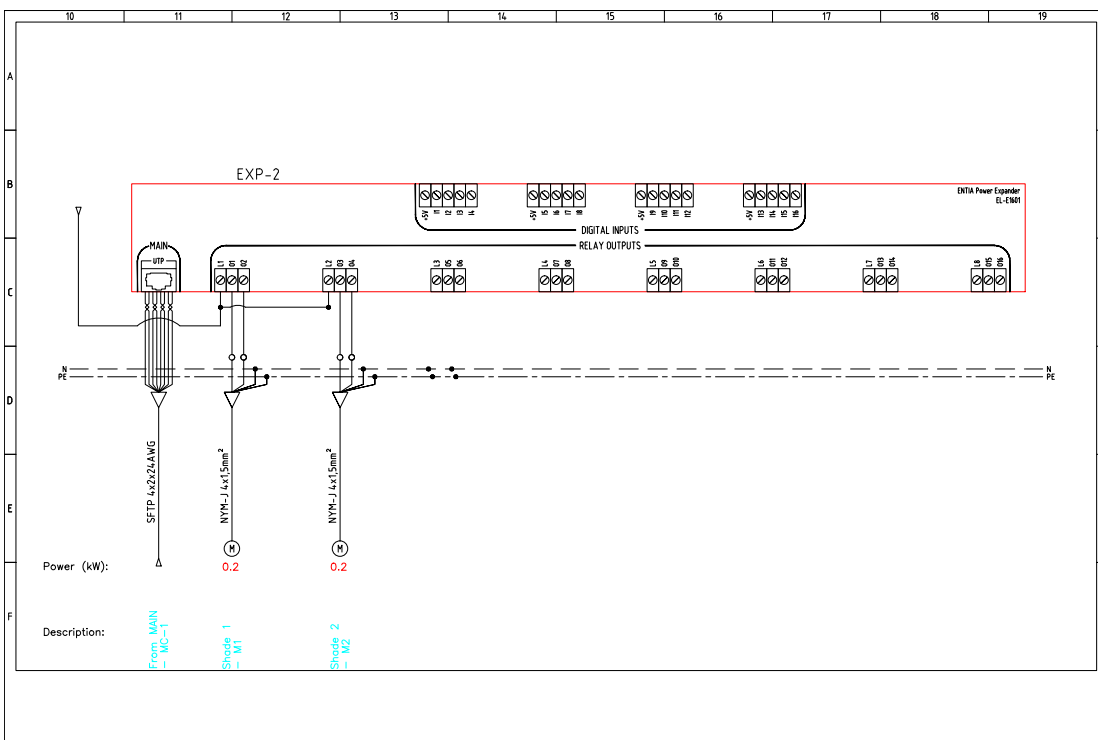
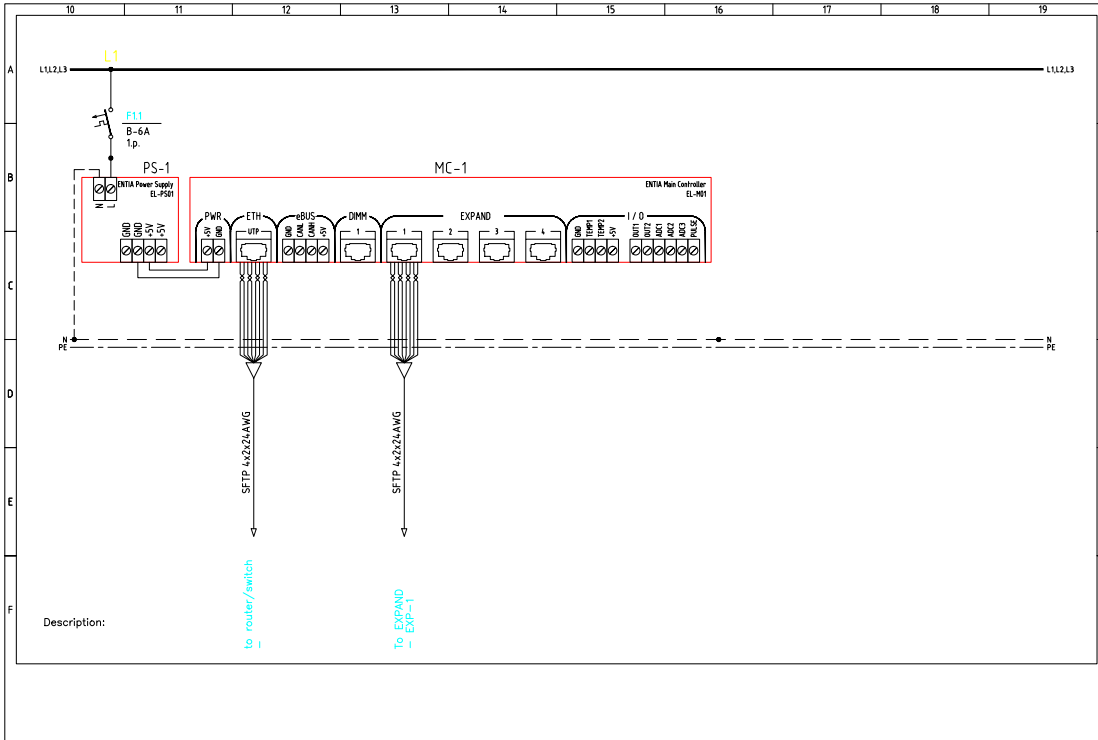

Air Conditioning

IR



Any IR remote controlled A/C device can be connected to the ENTIAliving system as shown in the block diagram below. Note that one ENTIAliving IR Controller EL-IR01 can support 1 air conditioning device. On the block diagram below, the elements and wiring for air conditioning connection is highlighted.

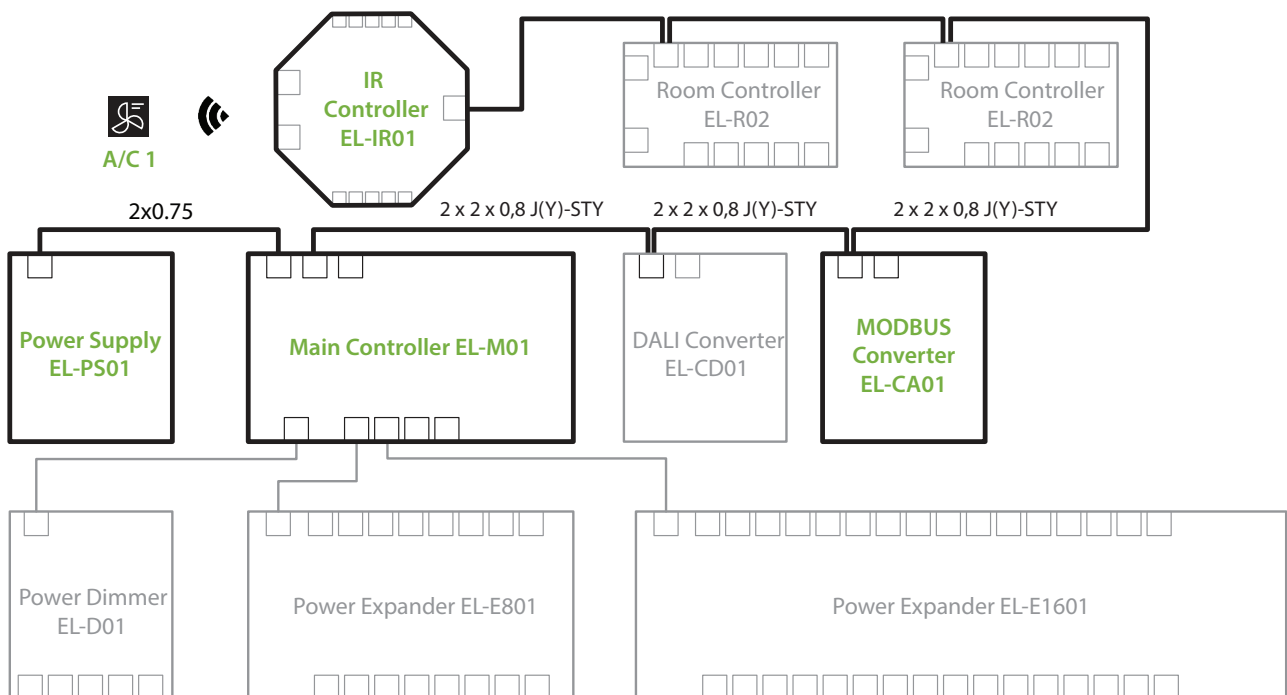

Air Conditioning

IR

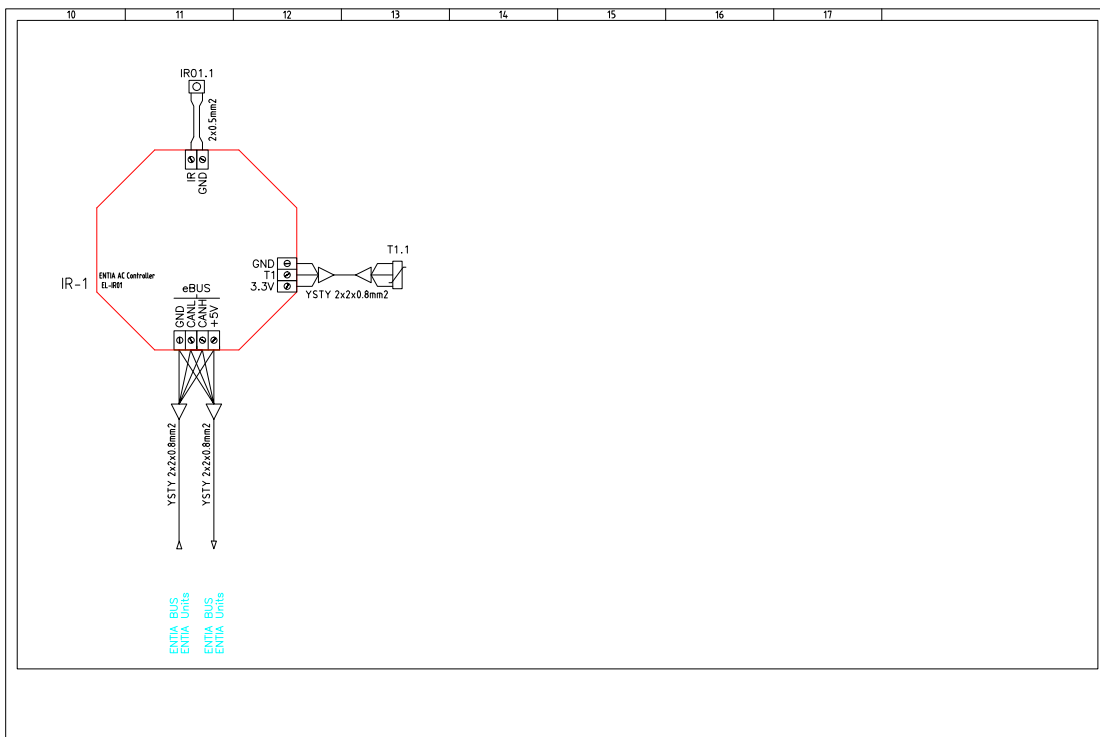
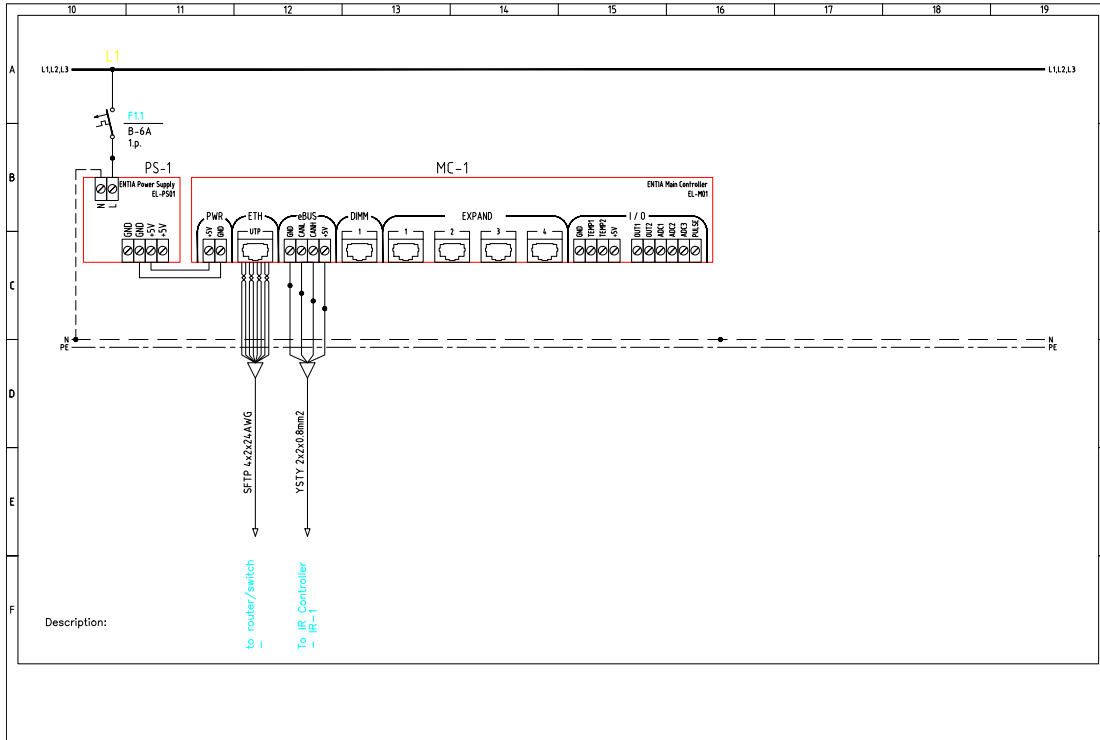

Air Conditioning

MODBUS



MODBUS compatible A/C devices have to be connected to the ENTIALiving system as shown in the block diagram below. Note that one ENTIALiving MODBUS Converter EL-CA01 can support up to 256 air conditioning devices. On the block diagram below, the elements and wiring for air conditioning connection is highlighted.

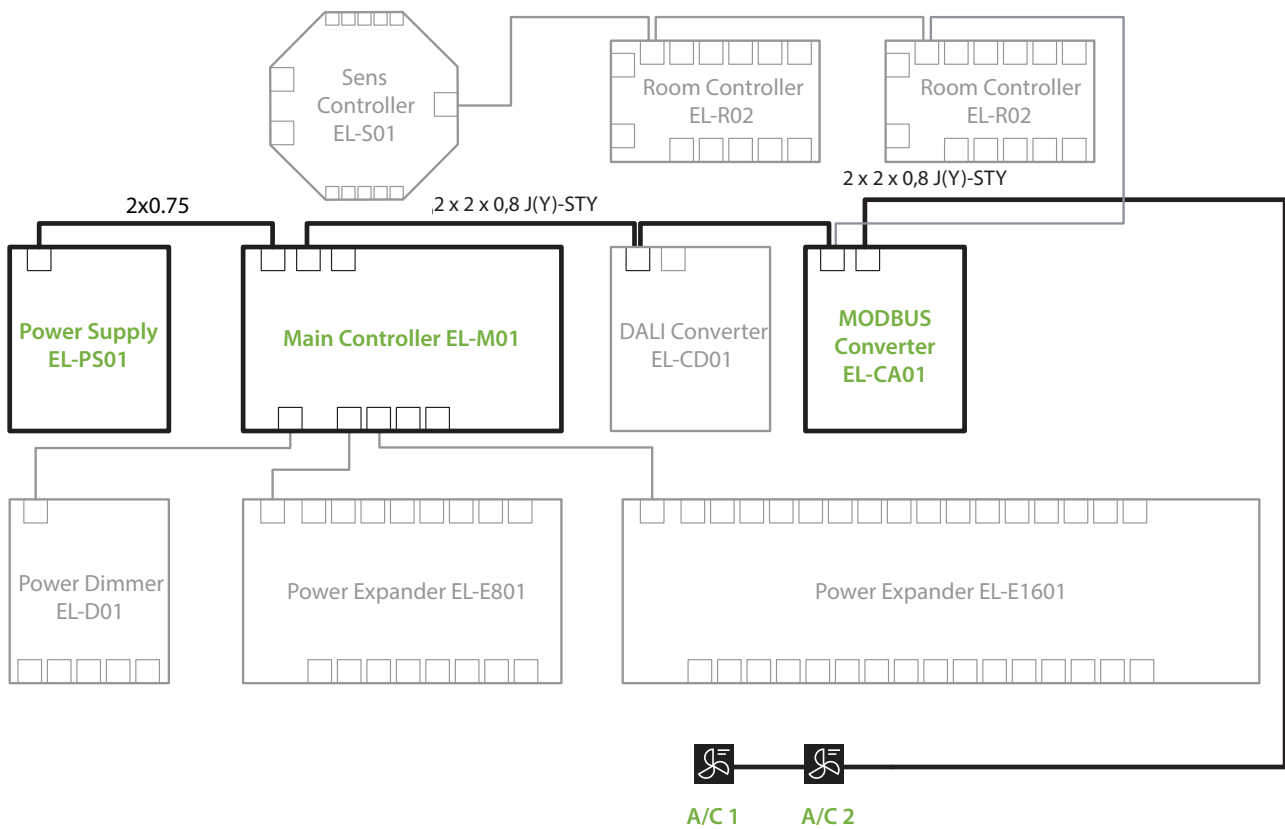

Air Conditioning

MODBUS

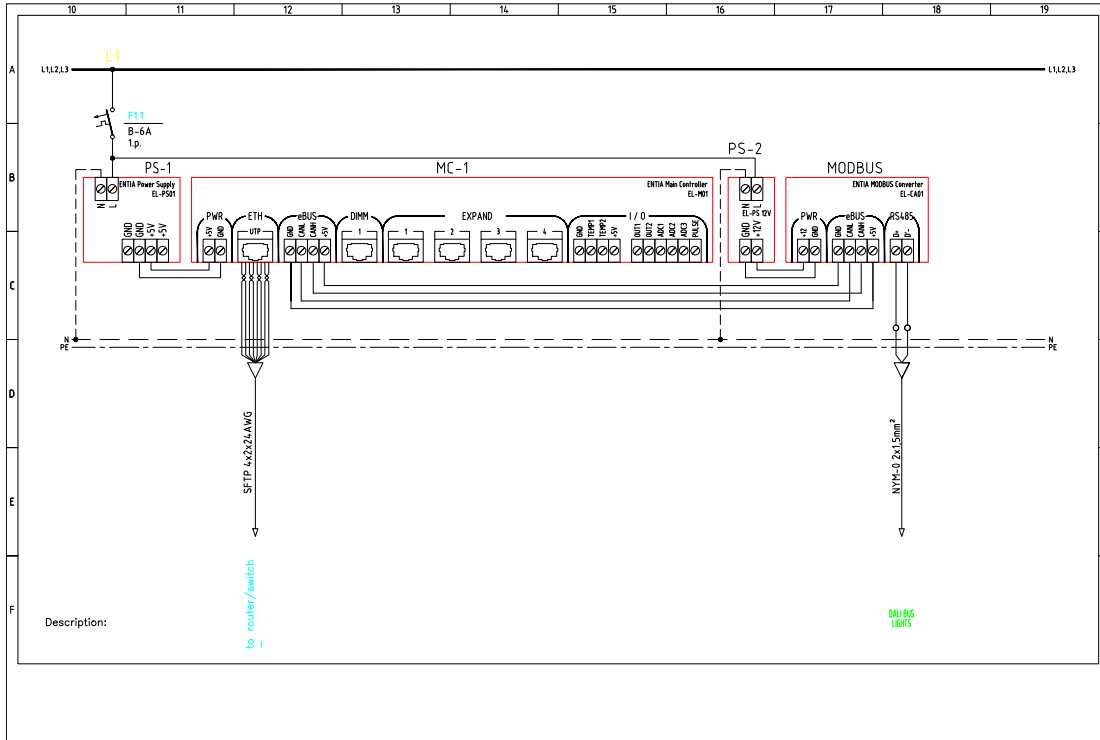

CAN Units

ENTIA living CAN (eBUS) controllers, such as Main Controller EL-M01, Main Controller EL-M01a, Room Controller EL-R02, DALI Converter EL-CD01, MODBUS Converter EL-CA01 and Sens Controller EL-S01 have to be connected as shown in the block diagram below. Note that on the block diagram below, the CAN elements and wiring is highlighted. The order in which CAN devices are interconnected is of no consequence (e.g. we could start with a Room Controller instead of the Main Controller). Multiple Main Controllers can be connected in one eBUS circuit, if required (e.g. in case of more than 64 power outputs).

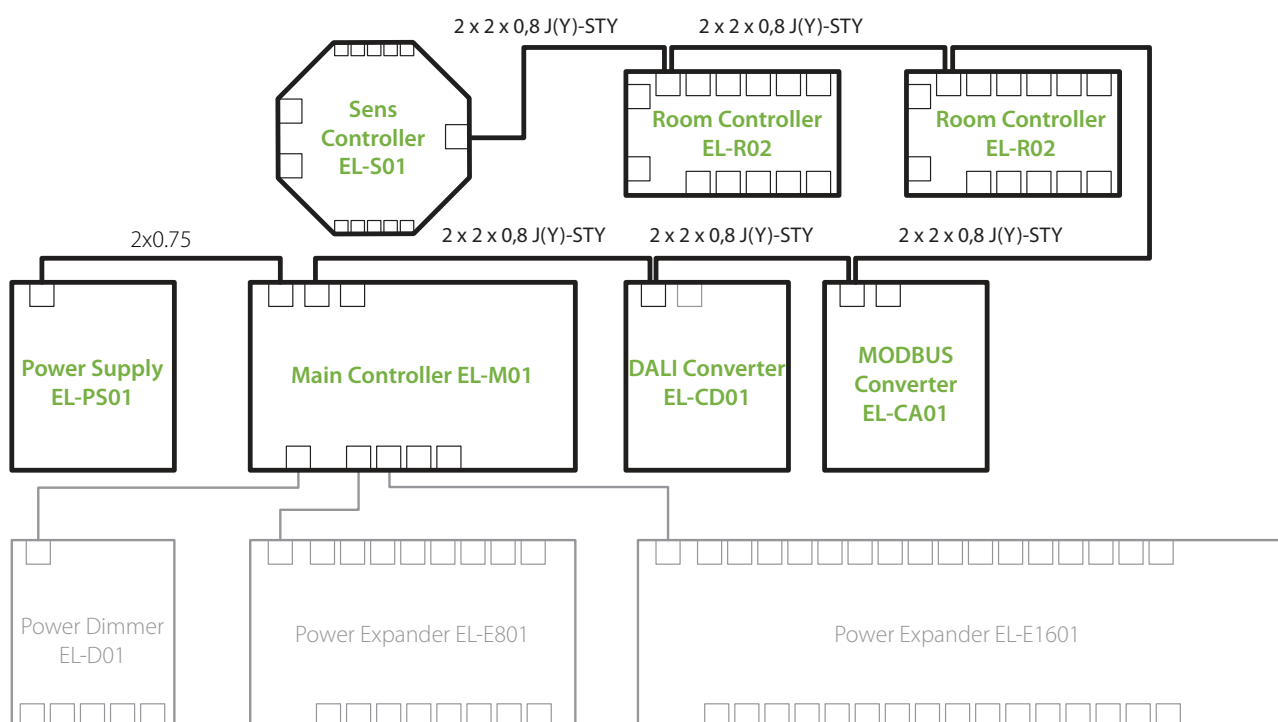

CAN Units

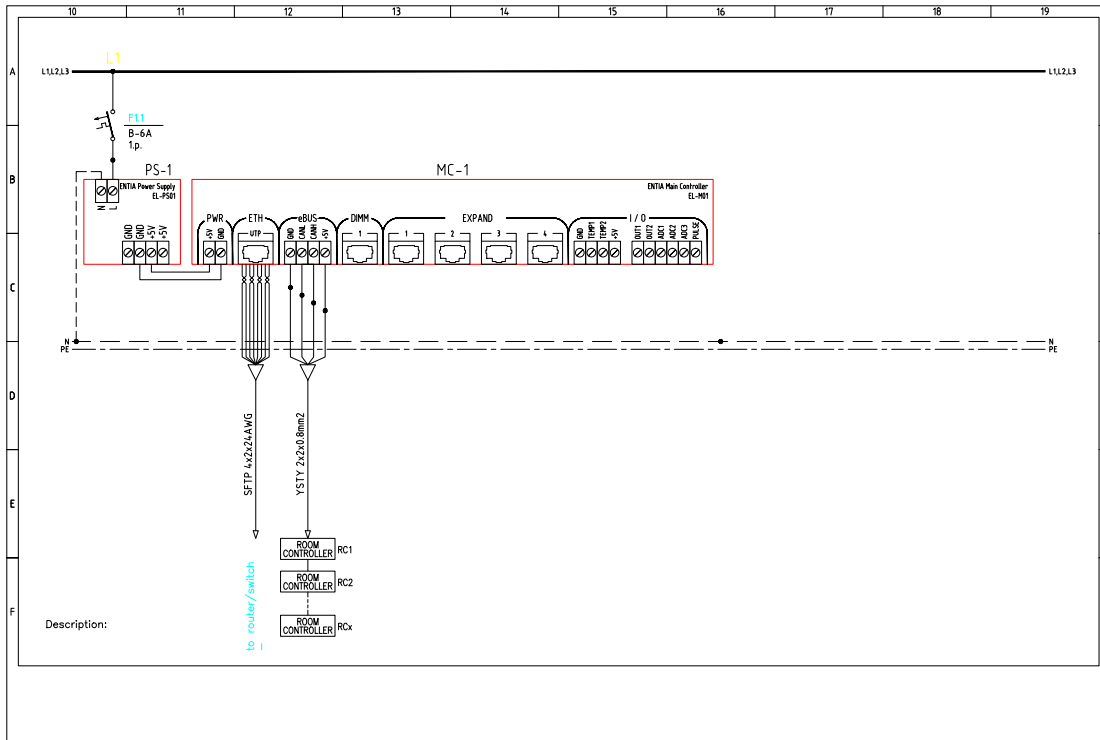

Buttons & Switches

Power Expander connect

Below is the block diagram for connecting inputs (buttons, switches, digital sensors) to the ENTIA living system via the Power Expander (EL-E801 and EL-E1601) modules. Up to 8 digital inputs can be connected to the EL-E801 module and up to 16 digital inputs to the EL-E1601 module.

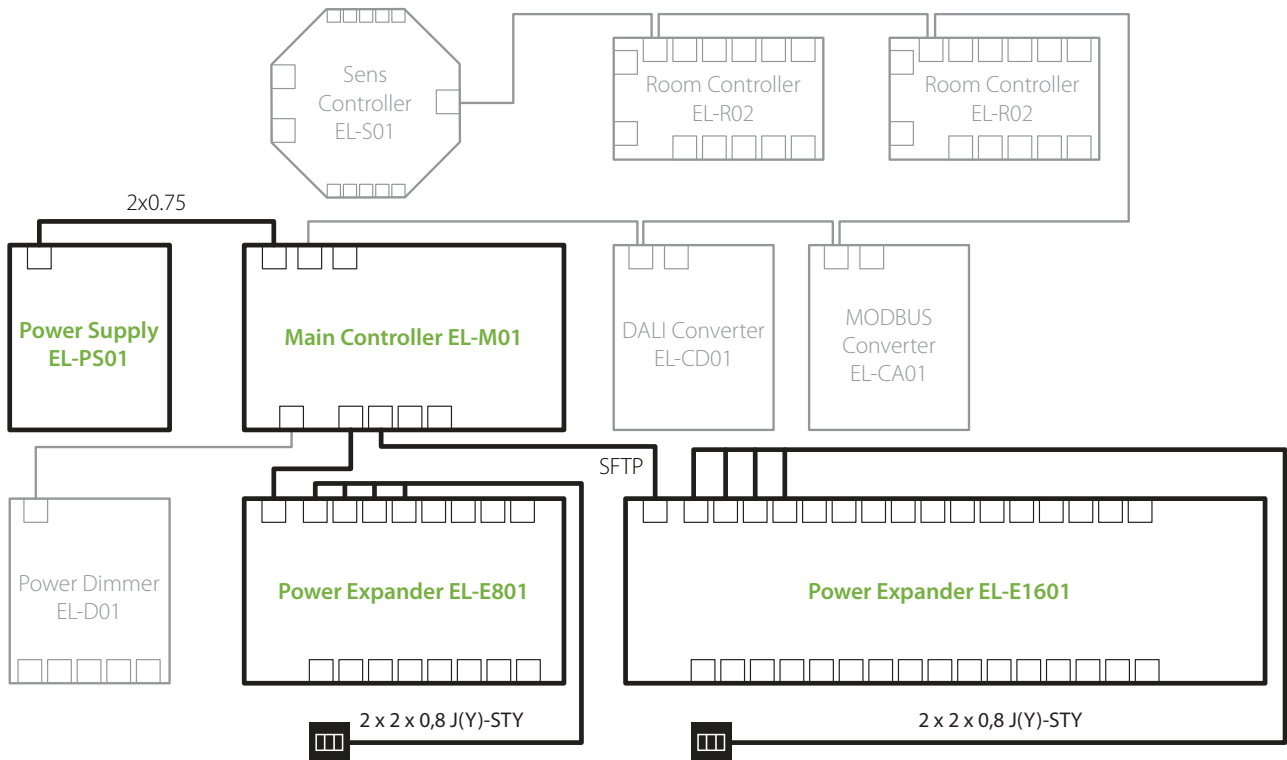

Buttons & Switches

Power Expander connect

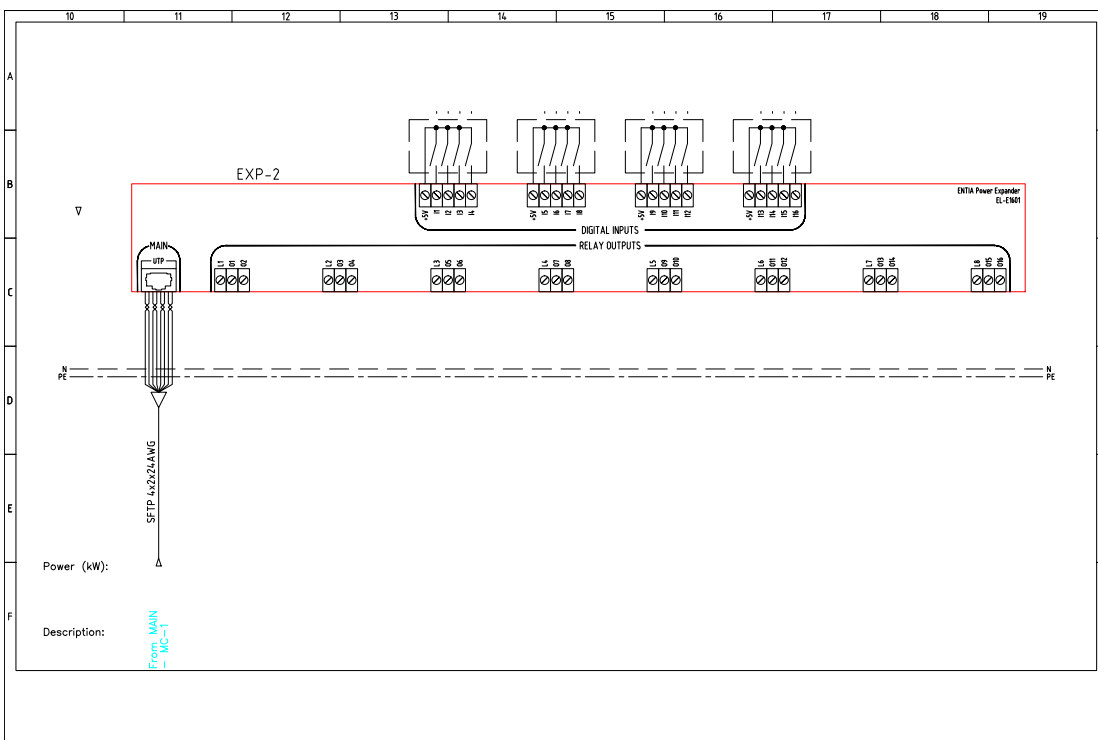
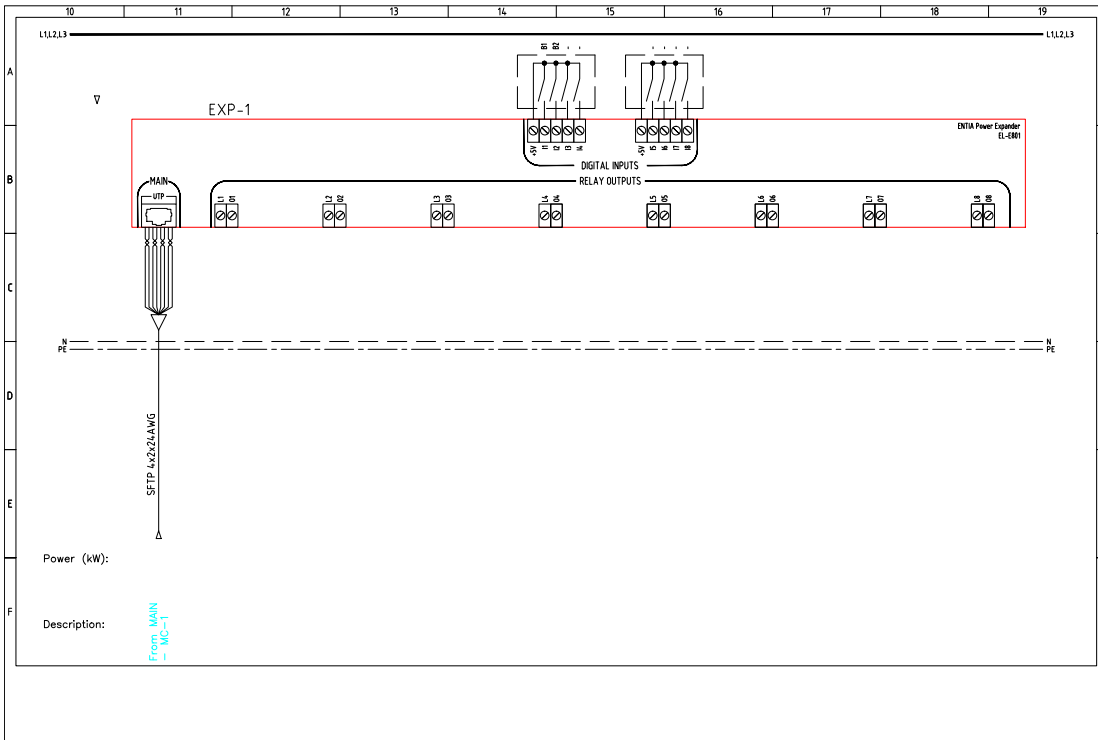

Buttons & Switches

BUS connect

Below is the block diagram for connecting inputs (buttons, switches, digital sensors) to the ENTIALiving system via the Room Controller and/or Sens Controller (EL-R02 and EL-S01) modules. Up to 10 digital inputs can be connected to either EL-R02 or EL-S01 module.

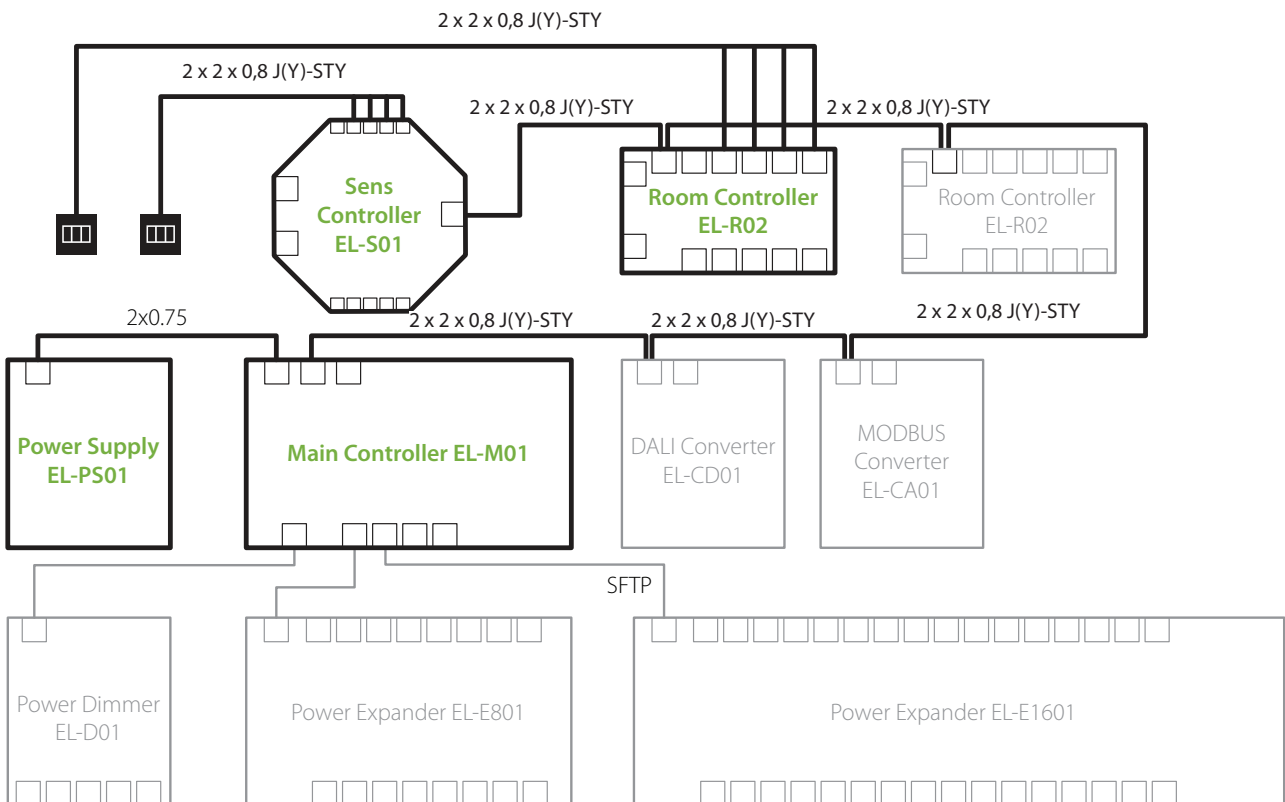

Buttons & Switches

BUS connect

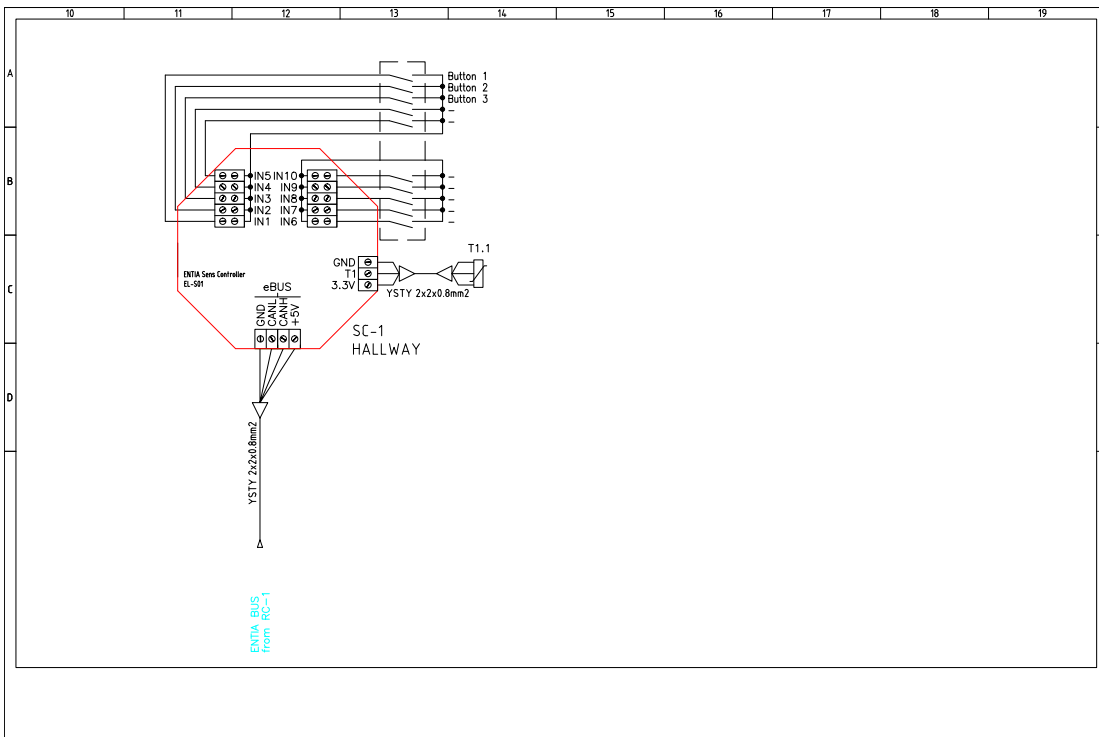
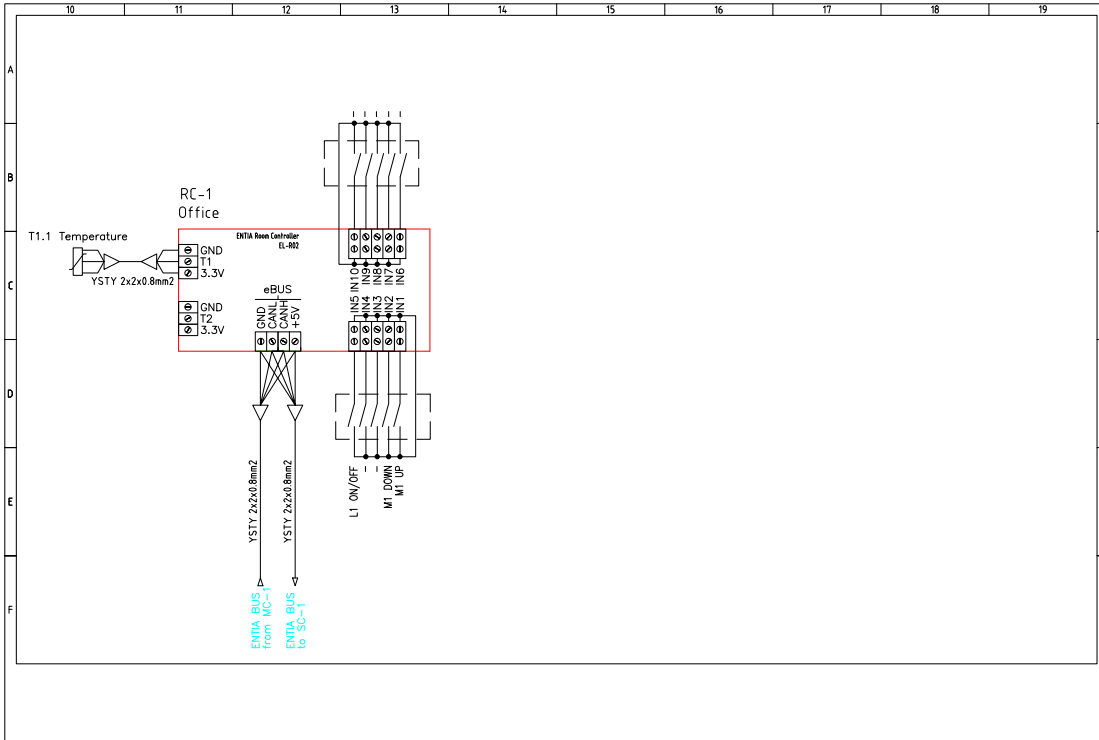

ABOUT THE COMPANY

*Our mission is to make ordinary people's lives easier, more effective and less costly. We are believers, enthusiasts, engineers, explorers, achievers... We are **Entia**.*

The company **Entia** was founded in 2009 and the product **ENTIAliving** was "born" a year later. A cloud based smart home for new residential buildings that increases the energy efficiency, security and comfort of a home while enabling world wide remote control with smartphones, tablets or personal computers. Assembled with the highest quality components and

manufactured in European Union, **ENTIAliving** covers all the functionality of any smart home system available on the market, adding cloud related advantages, such as world wide monitoring and remote control, remote management and service etc. **ENTIAliving** is moving a luxury product into the mass market thus making smart home widely affordable.

CE standards

The **ENTIAliving** system has passed all the necessary tests to achieve the following standards of quality assurance:

- EN 60730-1
- EN 55015
- EN 61547
- EN 61000-3-2
- EN 61000-3-3
- EN 50491-2
- EN 50491-5-1
- EN 50491-5-2
- EN 50491-5-3
- EN 50491-3 (EN 50090:1998 + A1:2002 + A2:2007)



